

Bezel - 36mm / 1.42in
Aperture - 18.6mm / 0.73in

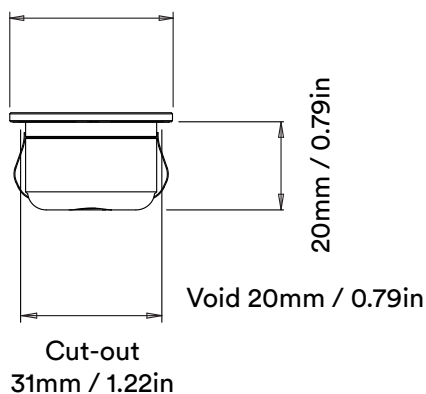

35mm / 1.38in

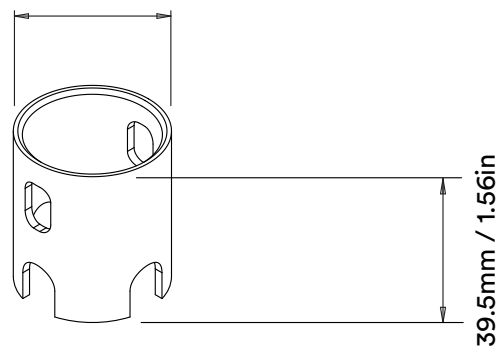

**Optional Installation sleeve
for screeding and masonry
applications only**

How to Install

- Cut hole in installation surface as per above cut-out;
- Wire luminaire cable to Orluna certified driver, ensuring correct polarity (red to positive terminal [+] and black to negative terminal [-]). If multiple fittings are connected to a single driver the luminaires must be wired in series;
- With mains supply switched off, connect driver to mains supply (to avoid damaging the luminaire, do not hot-wire);
- Feed luminaire into cut-out pushing the light fitting fully into the installation surface. Ensure Ø250mm around luminaire and driver is left clear of insulation if being used.

Luminaire Details

Cut-out	Ø31mm	Class	III
Recess Depth	20mm	IP Rating	IP54/IP67
Clearance	Ø250mm	IP Zone	Zone 1
Fixing Method	Side Springs	Material	Aluminium ADC12
Max Driver Distance	20m	Cable type	2 Core 0.75mm ²
		Cable Length	300mm
		Bezel Temp	F Rated

