

Argent, a precious, *cloud.*

design Dodo Arslan
terzani.com

TERZANI
LA LUCE PENSATA







Name
Argent
pendant light

Materials
stainless steel



Finishes | Code

-  white disc | stainless steel
ON90S E7 C8 KK
 -  white disc | gold plated
ON90S L6 C8 KK
 -  white disc | rose gold plated
ON90S N4 C8 KK
 -  white disc | champagne plated
ON90S N1 C8 KK
- or on request
-  white disc | black nickel plated

Body

NO DRIVER INCLUDED

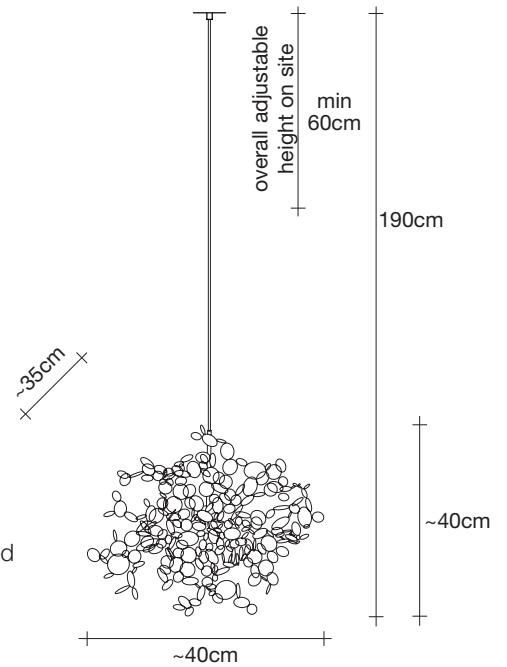

Light source options

12V ~ 50/60Hz

 HALOGEN
3 x 20W G4 12V

or

 LED
3 x 2W G4 12V

dimnable drivers available

 IGBT
10-100kΩ
0/1-10V
PUSH
DALI

Disc | white

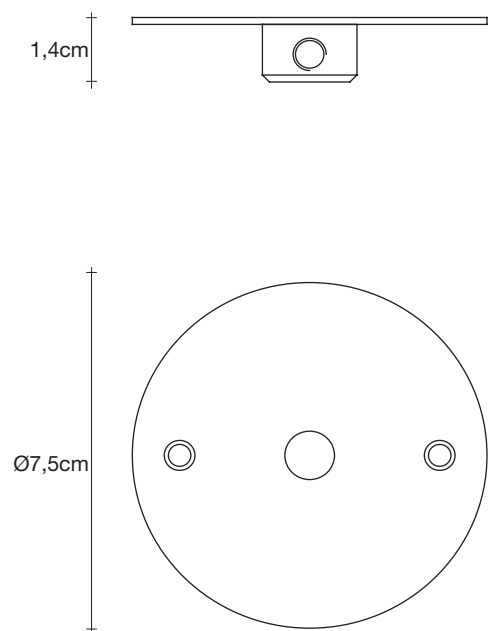

With this new suspension light, designer Dodo Arslan creates a shimmering, silver cloud. Argent consists of metal discs that have been meticulously joined by hand by Terzani craftsmen into clusters. Once lit, the multiple, angled surfaces of the discs emanate a soft, shimmering glow. Design Dodo Arslan.

Argent, a precious, *cloud.*

design Dodo Arslan
terzani.com

TERZANI
LA LUCE PENSATA







Name
Argent
pendant light

Materials
stainless steel

CE ENEC CB

Finishes | Code

-  stainless steel
ON90S E7 C8
 -  gold plated
ON90S L6 C8
 -  rose gold plated
ON90S N4 C8
 -  champagne plated
ON90S N1 C8
- or on request
-  black nickel plated

Body

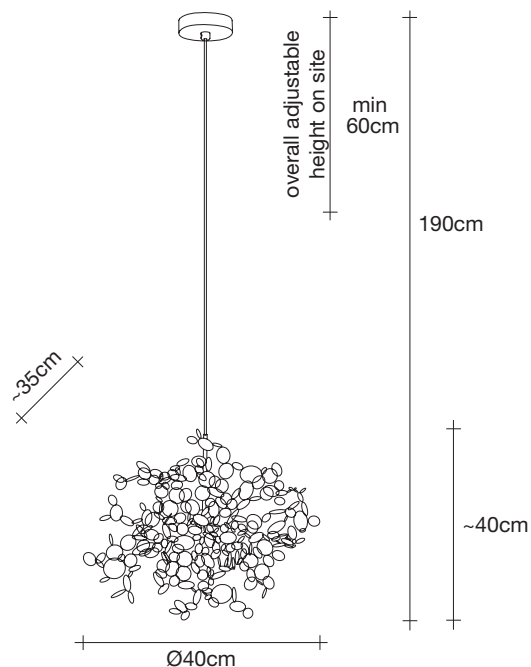

Light source options

230-240V ~ 50/60Hz

 HALOGEN
3 x 20W G4 12V

or

 LED
3 x 2W G4 12V

dimmable options

 not dimmable

 IGBT
TRIAC
DALI

Canopy

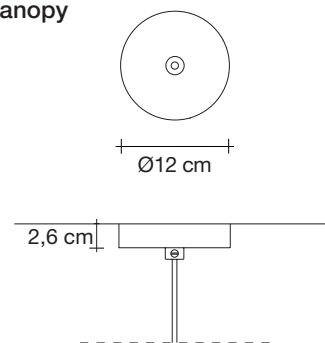

Canopy for DALI

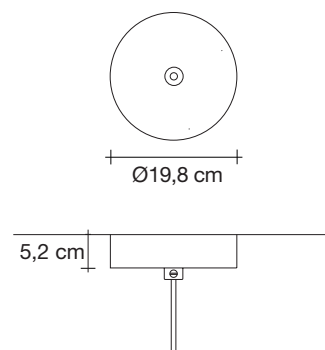

With this new suspension light, designer Dodo Arslan creates a shimmering, silver cloud. Argent consists of metal discs that have been meticulously joined by hand by Terzani craftsmen into clusters. Once lit, the multiple, angled surfaces of the discs emanate a soft, shimmering glow. Design Dodo Arslan.

Argent, a precious, *cloud.*

design Dodo Arslan
terzani.com

TERZANI
LA LUCE PENSATA







Name
Argent
4 round multi light pendant

Materials
stainless steel

CE ENEC CB

Finishes | Code

-  stainless steel
0N91S E7 C8
 -  gold plated
0N91S L6 C8
 -  rose gold plated
0N91S N4 C8
 -  champagne plated
0N91S N1 C8
- or on request
-  black nickel plated

Body

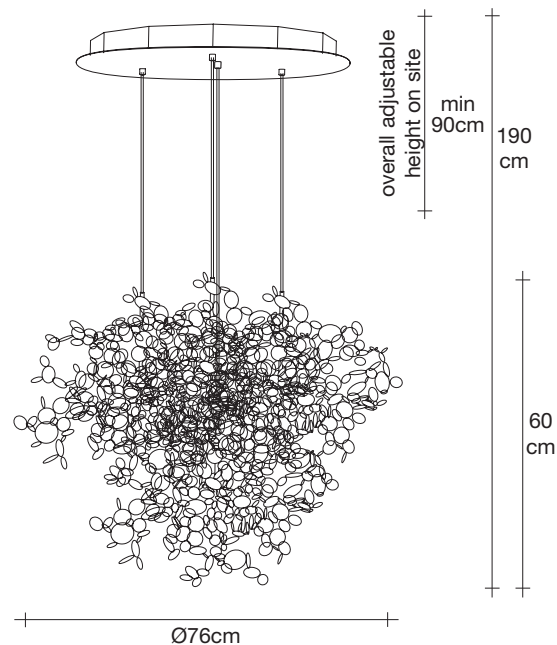

Light source options

230-240V ~ 50/60Hz

 HALOGEN
12 x 20W G4 12V

or

 LED
12 x 2W G4 12V

dimmable options

 IGBT
0/1-10V
PWM
10-100kΩ
PUSH
DALI

Canopy | white

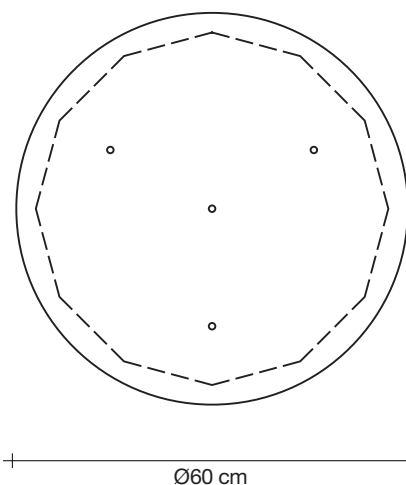

With this new suspension light, designer Dodo Arslan creates a shimmering, silver cloud. Argent consists of metal discs that have been meticulously joined by hand by Terzani craftsmen into clusters. Once lit, the multiple, angled surfaces of the discs emanate a soft, shimmering glow. Design Dodo Arslan.

Argent, a precious, *cloud.*

design Dodo Arslan
terzani.com

TERZANI
LA LUCE PENSATA





Name
Argent
4 linear multi light pendant

Materials
stainless steel

CE ENEC CB

Finishes | Code

-  stainless steel
0N92S E7 C8
-  gold plated
0N92S L6 C8
-  rose gold plated
0N92S N4 C8
-  champagne plated
0N92S N1 C8
- or on request
-  black nickel plated

Body

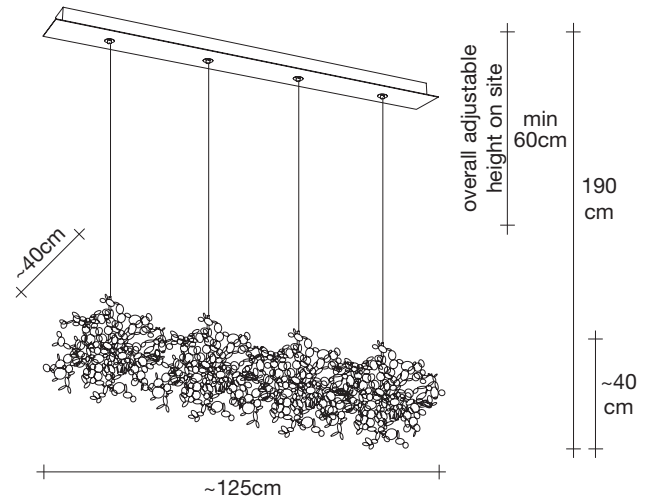

Light source options

230-240V ~ 50/60Hz

 HALOGEN
12 x 20W G4 12V

or

 LED
12 x 2W G4 12V

dimmable options

 IGBT
0/1-10V
PWM
10-100kΩ
PUSH
DALI

Canopy | white

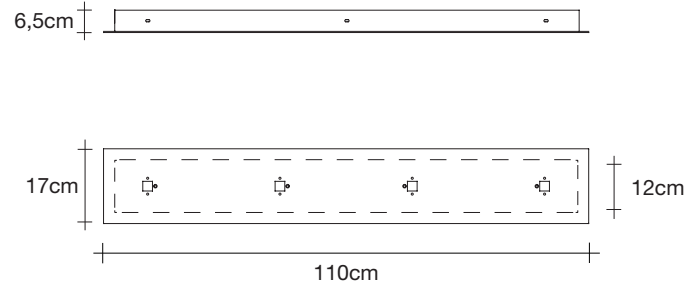

With this new suspension light, designer Dodo Arslan creates a shimmering, silver cloud. Argent consists of metal discs that have been meticulously joined by hand by Terzani craftsmen into clusters. Once lit, the multiple, angled surfaces of the discs emanate a soft, shimmering glow. Design Dodo Arslan.

Argent, a precious, *cloud.*

design Dodo Arslan
terzani.com

TERZANI
LA LUCE PENSATA







Name
Argent
6 linear multi light pendant

Materials
stainless steel

CE ENEC CB

Finishes | Code

-  stainless steel
0N89S E7 C8
-  gold plated
0N89S L6 C8
-  rose gold plated
0N89S N4 C8
-  champagne plated
0N89S N1 C8
- or on request
-  black nickel plated

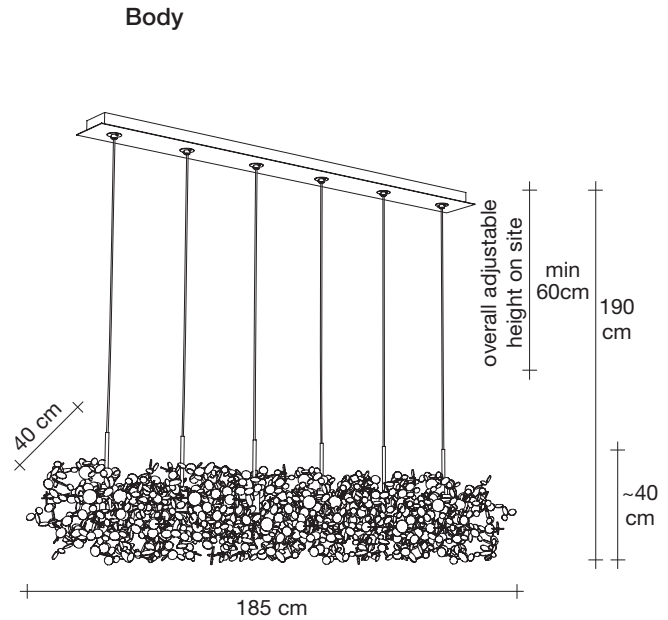

Light source options

230-240V ~ 50/60Hz

 HALOGEN
18 x 20W G4 12V

or

 LED
18 x 2W G4 12V

dimnable options

 IGBT
0/1-10V
PWM
10-100kΩ
PUSH
DALI

Canopy | white

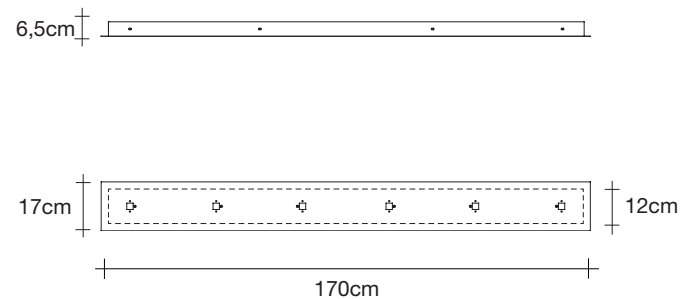

With this new suspension light, designer Dodo Arslan creates a shimmering, silver cloud. Argent consists of metal discs that have been meticulously joined by hand by Terzani craftsmen into clusters. Once lit, the multiple, angled surfaces of the discs emanate a soft, shimmering glow. Design Dodo Arslan.

Argent, a precious, *cloud.*

design Dodo Arslan
terzani.com

TERZANI
LA LUCE PENSATA







Name
Argent
small chandelier

Materials
stainless steel



Finishes | Code

-  stainless steel
ON95S E7 C8
-  gold plated
ON95S L6 C8
-  rose gold plated
ON95S N4 C8
-  champagne plated
ON95S N1 C8
- **or on request**
-  black nickel plated

Body

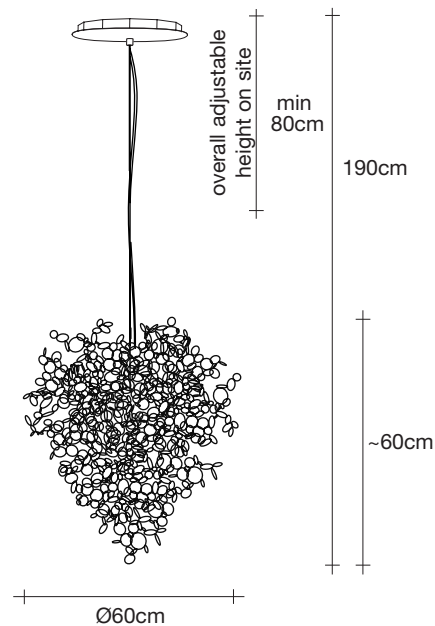

Light source
230-240V ~ 50/60Hz

-  Built in Replaceable LED Module
6 x 2,1W 1698 lm 3000K
or optional 1518 lm 2700K

dimnable options

-  0/1-10V
PUSH
DALI

Canopy

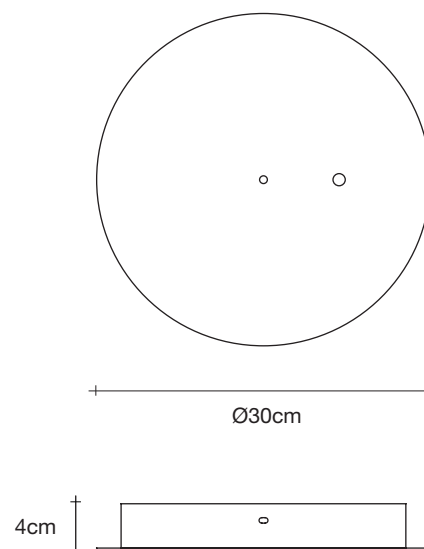

With this new suspension light, designer Dodo Arslan creates a shimmering, silver cloud. Argent consists of metal discs that have been meticulously joined by hand by Terzani craftsmen into clusters. Once lit, the multiple, angled surfaces of the discs emanate a soft, shimmering glow. Design Dodo Arslan.

Argent, a precious, *cloud.*

design Dodo Arslan
terzani.com

TERZANI
LA LUCE PENSATA



Name
Argent
medium chandelier

Materials
stainless steel



Finishes | Code

-  stainless steel
0N93S E7 C8
 -  gold plated
0N93S L6 C8
 -  rose gold plated
0N93S N4 C8
 -  champagne plated
0N93S N1 C8
- or on request
-  black nickel plated

Body

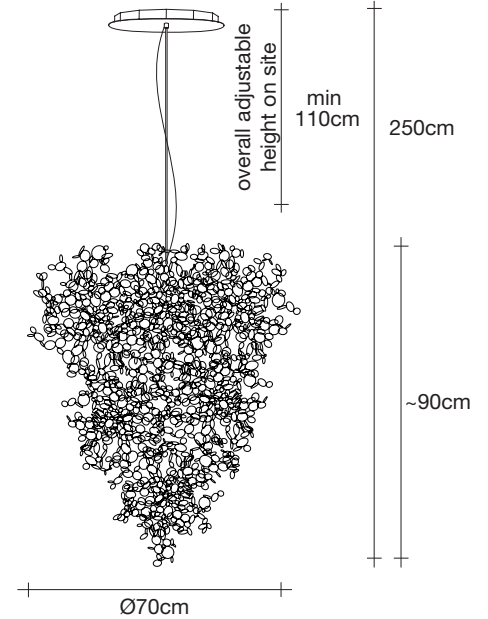

Light source
230-240V ~ 50/60Hz

-  Built in Replaceable LED Module
12 x 2,1W 3396 lm 3000K
or optional 3036 lm 2700K

dimnable options

-  1-10V
PUSH
DALI

Canopy | nickel or white

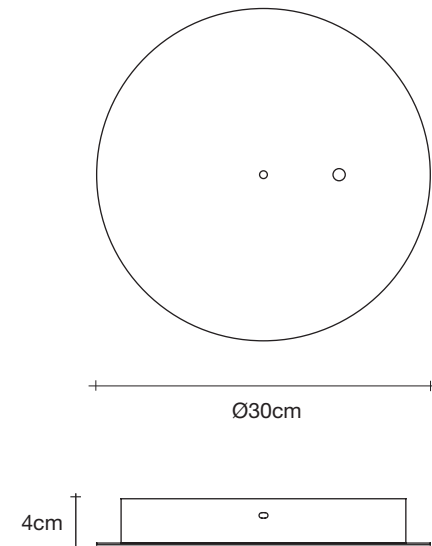

With this new suspension light, designer Dodo Arslan creates a shimmering, silver cloud. Argent consists of metal discs that have been meticulously joined by hand by Terzani craftsmen into clusters. Once lit, the multiple, angled surfaces of the discs emanate a soft, shimmering glow. Design Dodo Arslan.

Argent, a precious, *cloud.*

design Dodo Arslan
terzani.com

TERZANI
LA LUCE PENSATA







Name
Argent
large chandelier

Materials
stainless steel



Finishes | Code

-  stainless steel
0N94S E7 C8
-  gold plated
0N94S L6 C8
-  rose gold plated
0N94S N4 C8
-  champagne plated
0N94S N1 C8
- **or on request**
-  black nickel plated

Body

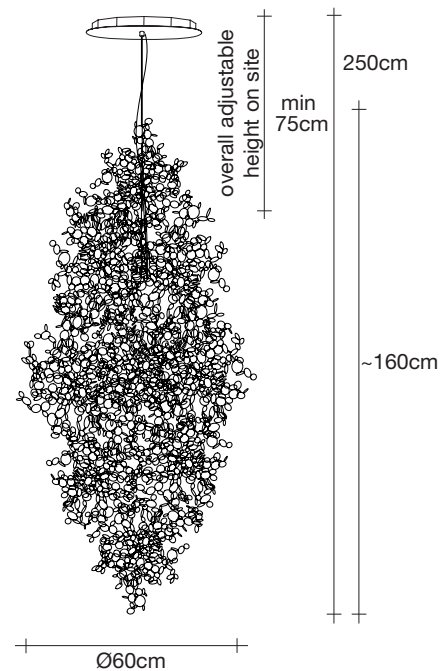

Light source
230-240V ~ 50/60Hz

-  Built in Replaceable LED Module
18 x 2,1W 5094 lm 3000K
or optional 4554 lm 2700K

dimnable options

-  PUSH
DALI

Canopy | nickel or white

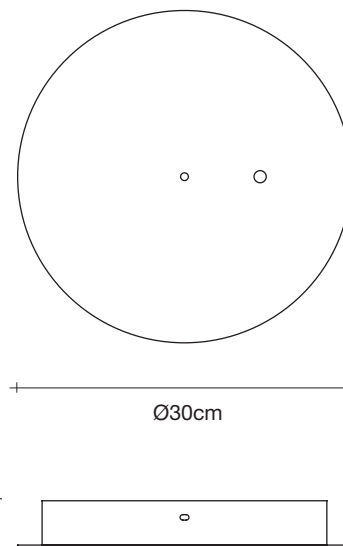

With this new suspension light, designer Dodo Arslan creates a shimmering, silver cloud. Argent consists of metal discs that have been meticulously joined by hand by Terzani craftsmen into clusters. Once lit, the multiple, angled surfaces of the discs emanate a soft, shimmering glow. Design Dodo Arslan.

Argent, a precious, *cloud.*

design Dodo Arslan
terzani.com

TERZANI
LA LUCE PENSATA



Name
Argent
ceiling light

Material
stainless steel

CE ENEC CB

Finishes | Code

-  stainless steel
0N99L E7 C8
-  gold plated
0N99L L6 C8
-  rose gold plated
0N99L N4 C8
-  champagne plated
0N99L N1 C8

Body

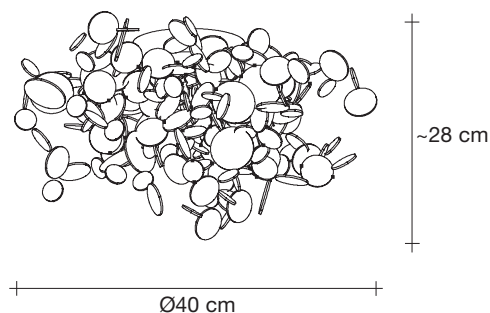

Light source options

230-240V ~ 50/60Hz

 HALOGEN
3 x 20W G4 12V

or

 LED
3 x 2W G4 12V

dimming options

 not dimmable

 IGBT
TRIAC
DALI

Canopy

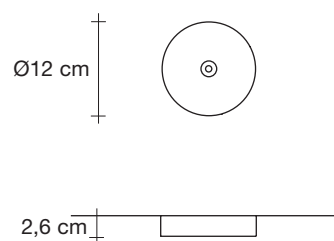

Canopy for DALI *

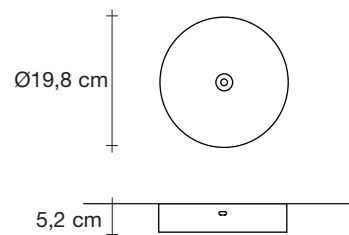

With this new suspension light, designer Dodo Arslan creates a shimmering, silver cloud. Argent consists of metal discs that have been meticulously joined by hand by Terzani craftsmen into clusters. Once lit, the multiple, angled surfaces of the discs emanate a soft, shimmering glow. Design Dodo Arslan. Made in Italy.

Argent, a precious, *cloud.*

design Dodo Arslan
terzani.com

TERZANI
LA LUCE PENSATA







Name
Argent
wall sconce

Materials
stainless steel

CE ENEC CB

Finishes | Code

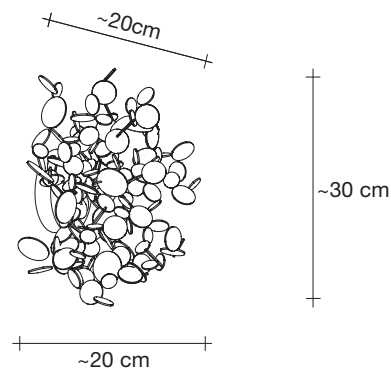

-  stainless steel
0N97A E7 C8
 -  gold plated
0N97A L6 C8
 -  rose gold plated
0N97A N4 C8
 -  champagne plated
0N97A N1 C8
- or on request
-  black nickel plated

Body



Light source options

230-240V ~ 50/60Hz

-  HALOGEN
3 x 20W G4 12V
or
-  LED
3 x 2W G4 12V

dimnable options

-  not dimmable
-  IGBT
TRIAC
DALI

Canopy

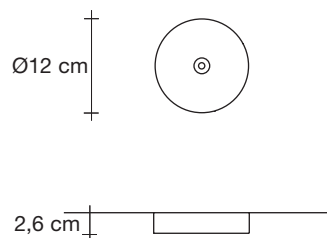

Canopy for DALI

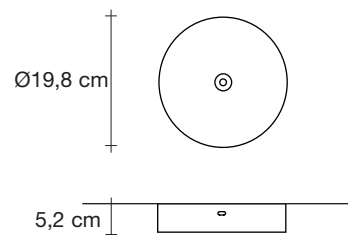

With this new suspension light, designer Dodo Arslan creates a shimmering, silver cloud. Argent consists of metal discs that have been meticulously joined by hand by Terzani craftsmen into clusters. Once lit, the multiple, angled surfaces of the discs emanate a soft, shimmering glow. Design Dodo Arslan.

Argent, a precious, *cloud.*

design Dodo Arslan
terzani.com

TERZANI
LA LUCE PENSATA



Name
Argent
table lamp

Materials
stainless steel



Finishes | Code

-  stainless steel
0N98B E7 C8
 -  gold plated
0N98B L6 C8
 -  rose gold plated
0N98B N4 C8
 -  champagne plated
0N98B N1 C8
- or on request
-  black nickel plated

Body

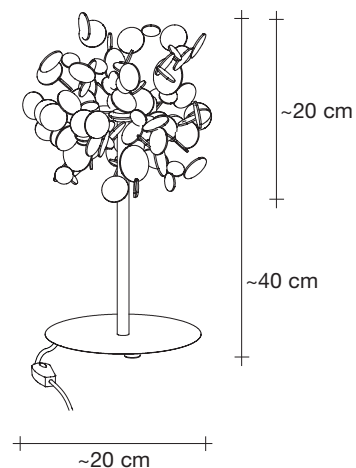

Light source

230-240V ~ 50/60Hz

 LED
3 x 2W G4 12V

 not dimmable

With this new suspension light, designer Dodo Arslan creates a shimmering, silver cloud. Argent consists of metal discs that have been meticulously joined by hand by Terzani craftsmen into clusters. Once lit, the multiple, angled surfaces of the discs emanate a soft, shimmering glow. Design Dodo Arslan.