

## Installation Guide

# PLUG-IN PENDANT

Thoughtful lighting, responsibly designed in London.

Thank you for making the switch to Tala.  
Discover the full Tala family at [tala.co.uk](http://tala.co.uk)

### BEFORE STARTING

Please read instructions thoroughly before installation and keep them for future reference. Please take extreme care when dealing with electrical equipment.

### IMPORTANT

Bulb must be installed in fixture before turning on.

### WARNING

Ensure power is turned OFF before inserting plug.  
Incorrect assembly may result in risk of fire or electric shock.

### CARE AND CLEANING

We recommend cleaning with a soft dry cloth. Do not use abrasive materials as these will damage the finish of the product.

### WARRANTY AND AFTER-CARE

This product has a two-year warranty.  
If there appears to be a functional defect with the product during this time, please contact our team at [customerservice@tala.co.uk](mailto:customerservice@tala.co.uk).  
Please note, the flexible cable attached to this luminaire cannot be replaced; if the cable is damaged, recycle the luminaire and seek a replacement.

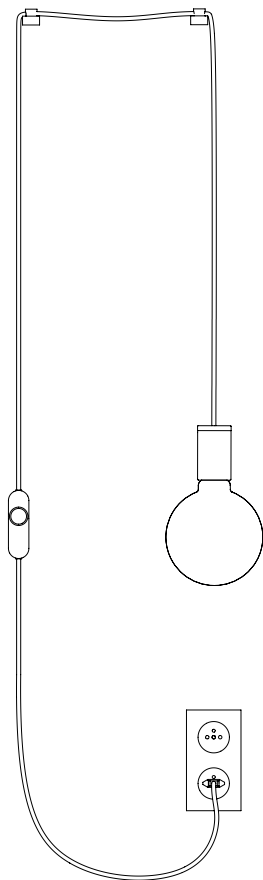

SKU - BRAS-PAP-01-EU  
SKU - GRAP-PAP-01-EU

SKU - WALT-PAP-01-EU  
SKU - OAK-PAP-01-EU

FOR INDOOR USE ONLY



This symbol  indicates that electrical and electronic equipment (WEEE) should not be mixed with general household waste. For recovery and recycling, please take this product to a designated collection point where it will be accepted free of charge. Many retailers offer this in-store. Disposing of this product correctly will help save valuable resources and prevent any potential negative effects on human health and the environment.

## Plug-in Pendant - Provided Components

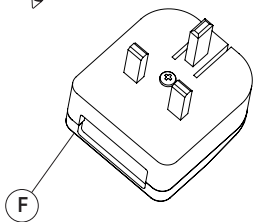
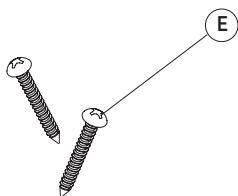
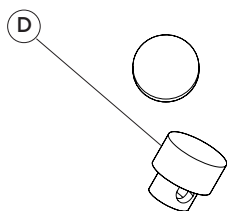
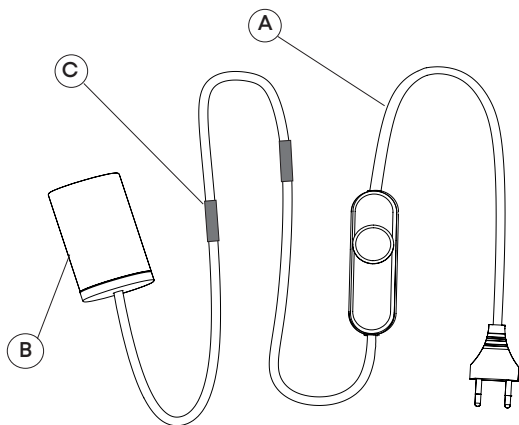

- (A)** x1 Cord with Dimmer Dial and US plug
- (B)** x1 Pre-assembled Tala Pendant Oak, Walnut, Brass or Graphite
- (C)** x2 Insulation tubes Adjustable - position in-line with nodes
- (D)** x2 Ceiling Nodes Consisting of 2 x caps and 2 x bases
- (E)** x1 Fixing Pack (Only use if suitable for ceiling type)
- (F)** x1 EU to UK Plug

Dimmer to pendant 13ft

Plug to dimmer 6.5ft

Layout 1



## STEP 1

Decide on your layout for the Plug-in pendant, some examples are shown below.

Ensure you have enough cable for your desired layout before setting up the pendant, and the dimmer is always accessible

Layout 2

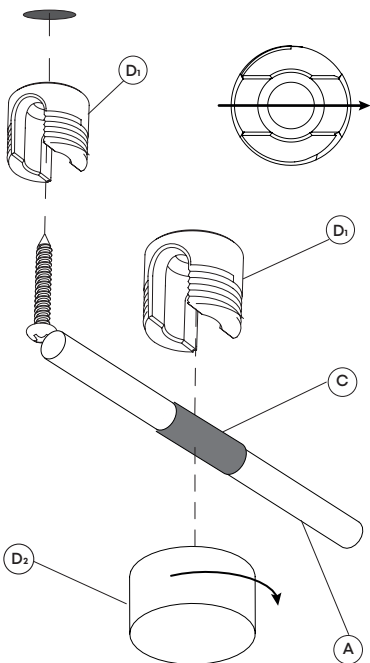
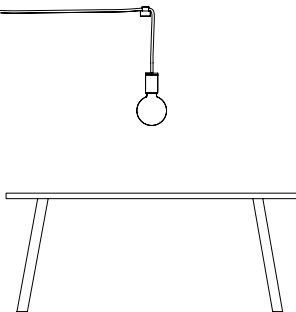

## STEP 2

Attach Node base (D<sub>1</sub>) to ceiling. Always choose screws and plugs that are appropriate for the ceiling material.

Ensure the Node channel runs parallel with the planned cord direction.

## STEP 3

Position the Cord (A) into the Node base (D<sub>1</sub>) at the desired points for your layout.

Slide the Insulation Tubes (C) into the centre of the Ceiling Nodes.

Screw the Node cap (D<sub>2</sub>) onto the Node base clockwise until secure. Do not over tighten.

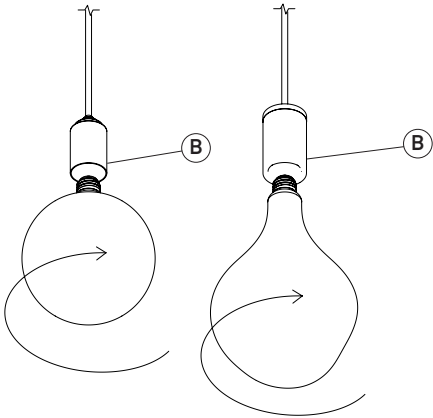

#### STEP 4

Insert your bulb into the pendant, rotating clockwise until tight.

Take care not to tighten too much to avoid breakage.

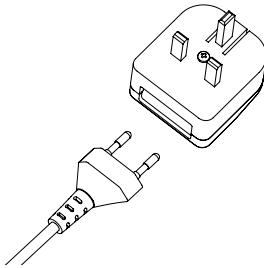

#### STEP 5

- FOR UK ONLY

Push the EU plug into the UK Adapter until it clicks in and the plug does not come loose.

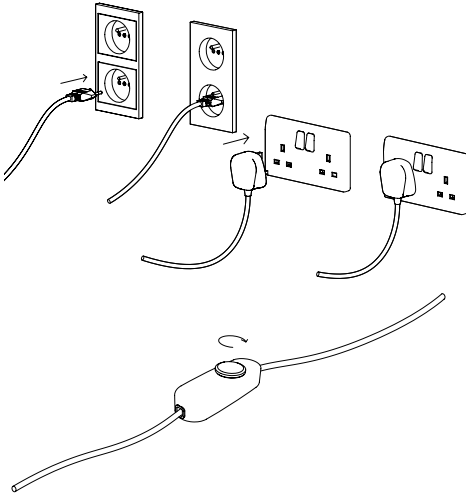

#### STEP 6

Insert the lamp plug into your chosen wall socket, making sure the power is switched off.

#### STEP 7

Switch the power on and rotate the dial on your dimmer until the bulb lights up. Adjust the dimmer for your desired light output.

### Join the Community

Instagram: @tala | Facebook: talaHQ | Pinterest: TalaLED | Tag: lighttoliveby

Tala Studios, 25B Vyner Street, London E2 9DG | hello@tala.co.uk

Tala Europe B.V, Bertus Aafjeshove 40, Nieuwegein 3437JN, Netherlands