

BERT FRANK



MASINA

HISTORY

Bert Frank is an award-winning British lighting brand founded by designer, Robbie Llewellyn and manufacturing specialist, Adam Yeats, who share a passion for life-enhancing design and a deep respect for the heritage of British engineering.

We remain committed to celebrating British craftsmanship and quality and to this day, we still manufacture and assemble every product exclusively in the UK from our factory in Birmingham, by combining traditional manufacturing methods with cutting-edge technology and the highest-quality materials.

Bert Frank's mission is to draw on influences from industrial hallmarks, art deco forms and mid-century design sensibilities, to create expressive lighting that honours the legacy of British design through their enduring quality, built to last a lifetime.

FINISHES

A curated selection of finishes, colours, and textures is available for all elements of the lighting pieces, offering endless possibilities to complement any interior design scheme. These options allow for complete creative freedom, enabling each piece to be customised to reflect the distinct aesthetic of a project.

SOLID BRASS METALWORK

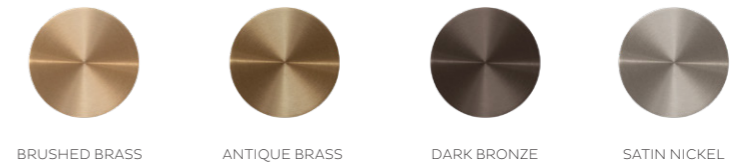

POWDER COAT FINISHES



CABLES



WALL LIGHT 200



MATERIALS
Brass | Powder coated detail | Opal glass

FINISHES
Standard finishes listed below
Bespoke finishes available upon request
Brasswork lacquered as standard

DIMMING
Non-dimmable as standard
Mains dimmable | TRIAC available

IP RATING
IP20 rated

LIGHT SOURCE
3W | E14 bulb | 110V/240V | 2700k

DIMENSIONS
H 393mm | W 262mm
H 15.5in | W 10.3in
2kg | 4.4lbs

WALL PLATE
Ø 116mm | Ø 4.6in

FINISHES



BRUSHED BRASS



ANTIQUÉ BRASS



DARK BRONZE



SATIN NICKEL

LINE DRAWINGS

SIDE VIEW

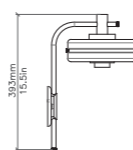

FRONT VIEW

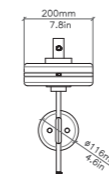

TOP VIEW

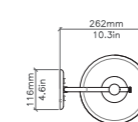

WALL LIGHT 300



MATERIALS

Brass | Powder coated detail | Opal glass

FINISHES

Standard finishes listed below
Bespoke finishes available upon request
Brasswork lacquered as standard

DIMMING

Mains dimmable | TRIAC available

IP RATING

IP20 rated

LIGHT SOURCE

7W | E14 bulb | 110V/240V | 2700k

DIMENSIONS

H 600mm | W 377mm
H 23.6in | W 14.8in
5kg | 11lbs

WALL PLATE

Ø 150mm | Ø 6in

FINISHES



BRUSHED BRASS



ANTIQUÉ BRASS



DARK BRONZE



SATIN NICKEL

LINE DRAWINGS

SIDE VIEW

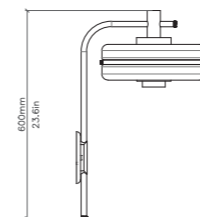

FRONT VIEW

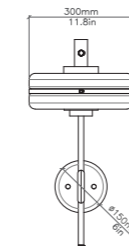

TOP VIEW

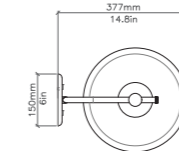

WALL LIGHT 400



MATERIALS

Brass | Powder coated detail | Opal glass

FINISHES

Standard finishes listed below
Bespoke finishes available upon request
Brasswork lacquered as standard

DIMMING

Mains dimmable | TRIAC available

IP RATING

IP20 rated

LIGHT SOURCE

8.5W | E27 bulb (not supplied) | 110V/240V

DIMENSIONS

H 765mm | W 495mm
H 30in | W 19.5in
9kg | 19.8lbs

WALL PLATE

Ø 180mm | Ø 7in

FINISHES



BRUSHED BRASS ANTIQUE BRASS DARK BRONZE SATIN NICKEL

LINE DRAWINGS

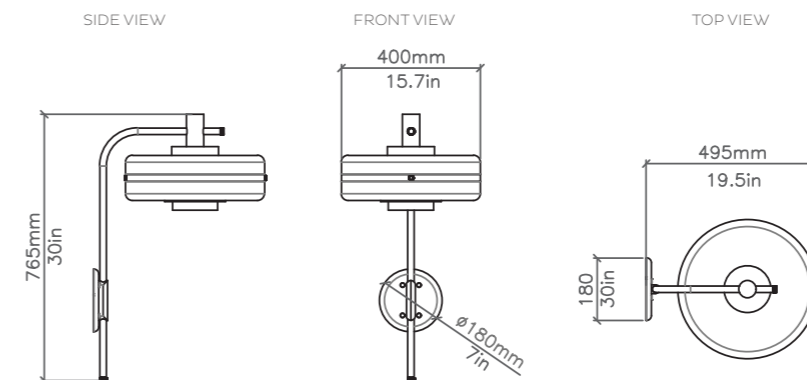





BERT FRANK

+44 (0) 207 164 6482 | sales@bertfrank.co.uk
www.bertfrank.co.uk | 67 Farringdon Road, London EC1M 3JB, UK