

Mizu, flowing light.

design Nicolas Terzani
terzani.com



Name
Mizu
pendant light

Materials
crystal



Finishes | Code

-  white disc | clear
OR01S E8 A9 KK
-  white disc | champagne
OR01S E8 H1 KK
-  white disc | cognac
OR01S E8 H4 KK
-  white disc | silver dust
OR01S E8 F4 KK
-  white disc | gold
OR01S E8 A4 KK

Body

NO DRIVER INCLUDED

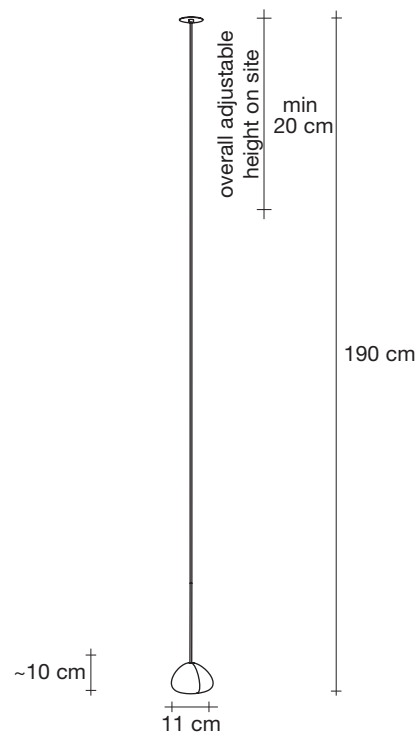

Light source options

12V ~ 50/60Hz



or



500mA ~ 50/60Hz



dimnable drivers available



Disc | white

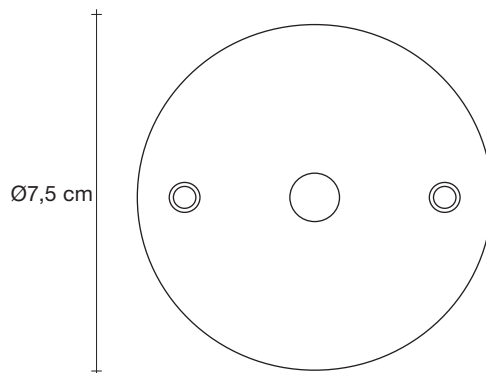
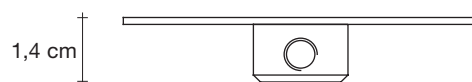

Inspired by the tranquil and mesmerizing light refractions created by water, Mizu is a customizable pendant light from Terzani. Like water droplets, no two Mizu are alike, each crystal shape is unique and made meticulously by hand. Using only the clearest crystal, Mizu perfectly emulates water's refraction of light, casting amazing patterns around the room, reminiscent of flowing water. Available in clear, silver dust, gold, cognac and champagne finish. Design Nicolas Terzani. Made in Italy.

Mizu, flowing *light*.

design Nicolas Terzani
terzani.com

TERZANI
LA LUCE PENSATA



Name
Mizu
pendant light

Materials
crystal

CE ENEC CB

Finishes | Code

-  clear
OR01S H4 A9
-  champagne
OR01S E8 H1
-  cognac
OR01S E8 H4
-  silver dust
OR01S H4 F4
-  gold
OR01S E8 A4

Body

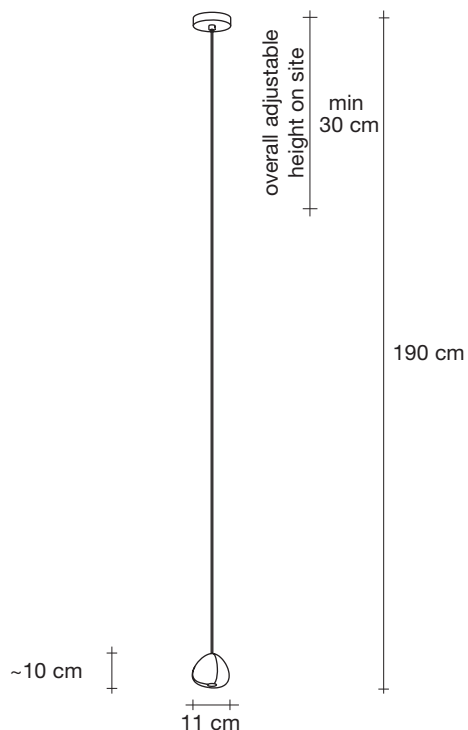

Light source options

230-240V ~ 50/60Hz

 HALOGEN
10W G4 12V

or

 LED
2W G4 12V
3W G4 12V

or

 Built in Replaceable LED Module
1,5W 146 lm 3000K
or optional 129 lm 2700K

dimming options

 not dimmable

 IGBT
TRIAC
DALI

Inspired by the tranquil and mesmerizing light refractions created by water, Mizu is a customizable pendant light from Terzani. Like water droplets, no two Mizu are alike, each crystal shape is unique and made meticulously by hand. Using only the clearest crystal, Mizu perfectly emulates water's refraction of light, casting amazing patterns around the room, reminiscent of flowing water. Available in clear, silver dust, gold, cognac and champagne finish. Design Nicolas Terzani. Made in Italy.

Canopy | white or brushed nickel plated

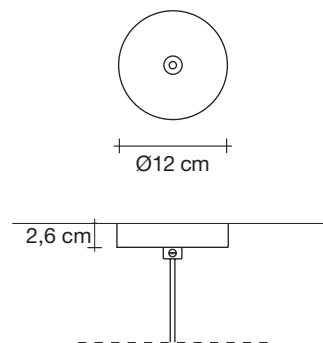

Canopy for DALI | white or brushed nickel plated *

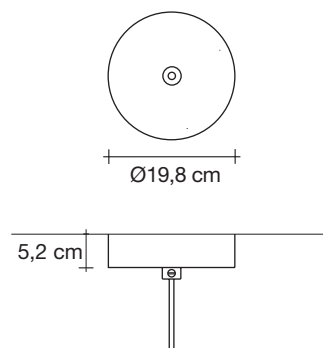

Mizu, flowing light.

design Nicolas Terzani
terzani.com

TERZANI
LA LUCE PENSATA



Name
Mizu
3 light pendant

Materials
crystal

CE ENEC CB

Finishes | Code

-  clear
OR03S H4 A9
-  champagne
OR03S E8 H1
-  cognac
OR03S E8 H4
-  silver dust
OR03S H4 F4
-  gold
OR03S E8 A4

Body

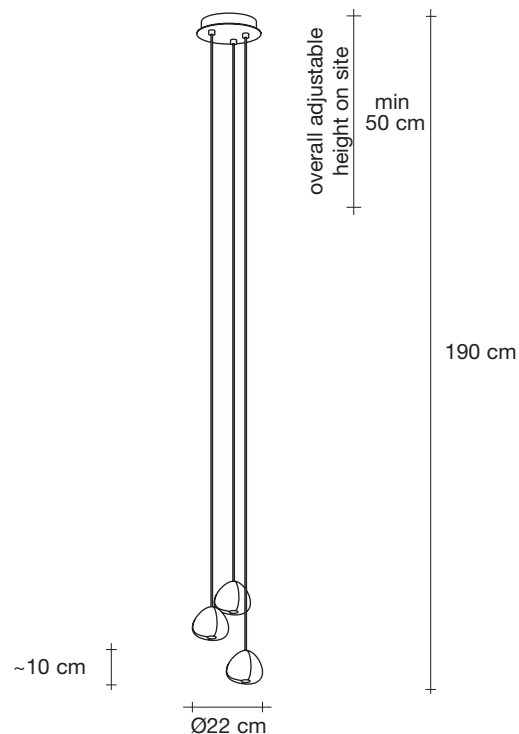

Light source options

230-240V ~ 50/60Hz

 HALOGEN
3 x 10W G4 12V

or

 LED
3 x 2W G4 12V

or

 Built in Replaceable LED Module
3 x 1,5W 438 lm 3000K
or optional 387 lm 2700K

dimnable options

 not dimmable

 IGBT
1-10V
PUSH
DALI

Canopy | white or brushed nickel plated

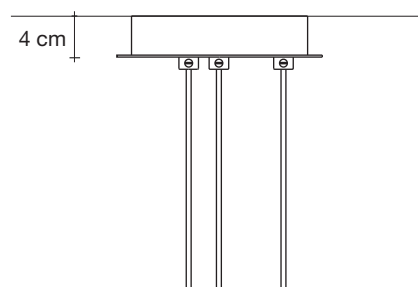
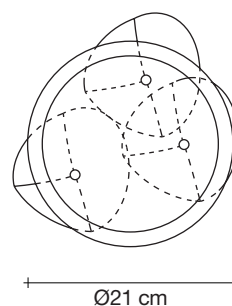

Inspired by the tranquil and mesmerizing light refractions created by water, Mizu is a customizable pendant light from Terzani. Like water droplets, no two Mizu are alike, each crystal shape is unique and made meticulously by hand. Using only the clearest crystal, Mizu perfectly emulates water's refraction of light, casting amazing patterns around the room, reminiscent of flowing water. Available in clear, silver dust, gold, cognac and champagne finish. Design Nicolas Terzani. Made in Italy.

Mizu, flowing *light*.

design Nicolas Terzani
terzani.com

TERZANI
LA LUCE PENSATA



Name

Mizu
5 light pendant

Materials

crystal

CE ENEC CB

Finishes | Code

-  clear
OR05S H4 A9
-  champagne
OR05S E8 H1
-  cognac
OR05S E8 H4
-  silver dust
OR05S H4 F4
-  gold
OR05S E8 A4

Body

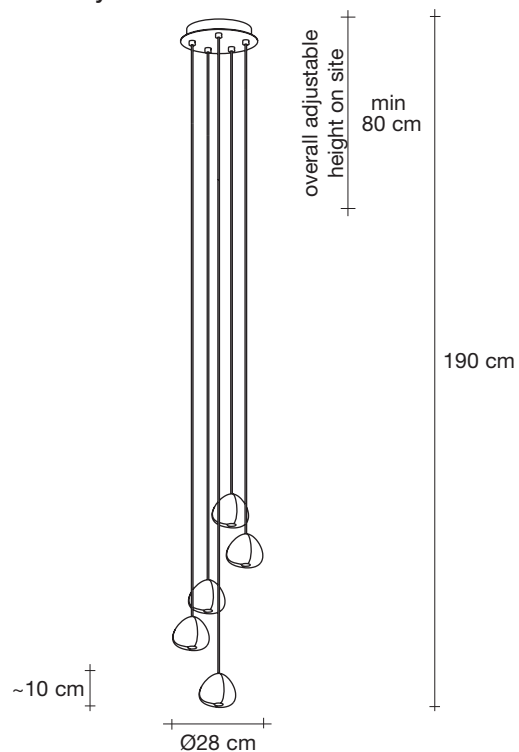

Light source options

230-240V ~ 50/60Hz

 HALOGEN
5 x 10W G4 12V

or

 LED
5 x 2W G4 12V

or

 Built in Replaceable LED Module
5 x 1,5W 730 lm 3000K
or optional 645 lm 2700K

dimnable options

 IGBT
0/1-10V
PWM
PUSH
DALI

Canopy | white or brushed nickel plated

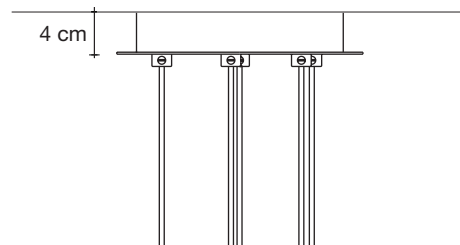
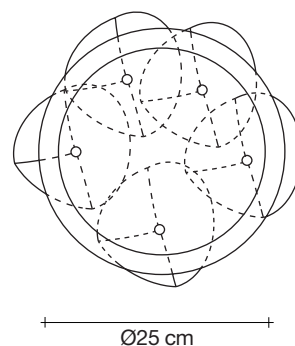

Inspired by the tranquil and mesmerizing light refractions created by water, Mizu is a customizable pendant light from Terzani. Like water droplets, no two Mizu are alike, each crystal shape is unique and made meticulously by hand. Using only the clearest crystal, Mizu perfectly emulates water's refraction of light, casting amazing patterns around the room, reminiscent of flowing water. Available in clear, silver dust, gold, cognac and champagne finish. Design Nicolas Terzani. Made in Italy.

Mizu, flowing *light*.

design Nicolas Terzani
terzani.com

TERZANI
LA LUCE PENSATA



Name
Mizu
7 light pendant

Materials
crystal

CE ENEC CB

Finishes | Code

-  clear
OR07S H4 A9
-  champagne
OR07S E8 H1
-  cognac
OR07S E8 H4
-  silver dust
OR07S H4 F4
-  gold
OR07S E8 A4

Body

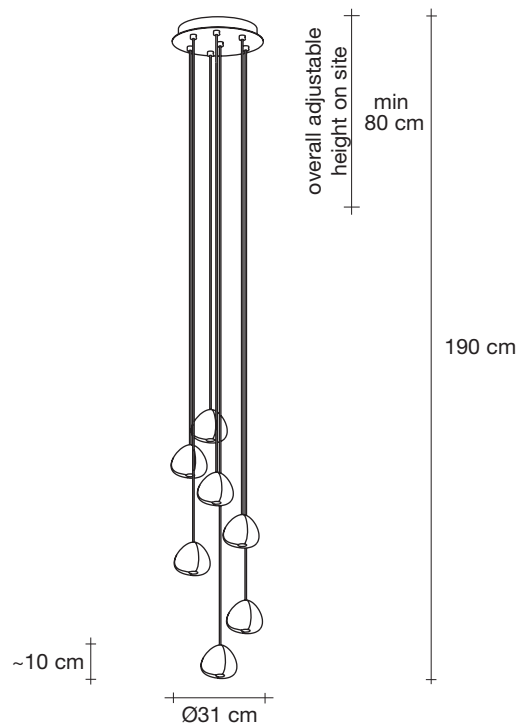

Light source options

230-240V ~ 50/60Hz

 HALOGEN
7 x 10W G4 12V

or

 LED
7 x 2W G4 12V

or

 Built in Replaceable LED Module
7 x 1,5W 1022 lm 3000K
or optional 903 lm 2700K

dimnable options

 IGBT
0/1-10V
PWM
PUSH
DALI

Canopy | white or brushed nickel plated

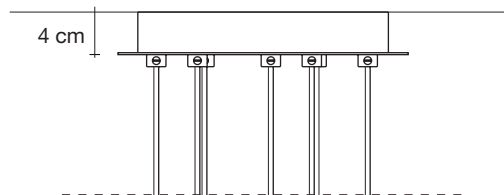
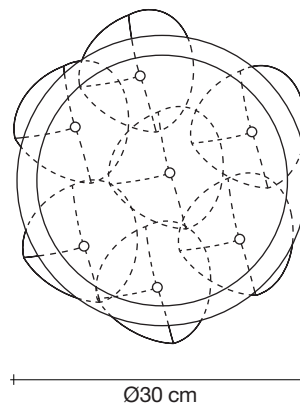

Mizu, flowing *light*.

design Nicolas Terzani
terzani.com

TERZANI
LA LUCE PENSATA







Name
Mizu
15 rectangular multi light pendant

Materials
crystal

CE ENEC CB

Finishes | Code

-  clear
OR15S E8 A9 R
-  champagne
OR15S E8 H1 R
-  cognac
OR15S E8 H4 R
-  silver dust
OR15S E8 F4 R
-  gold
OR15S E8 A4 R

Body

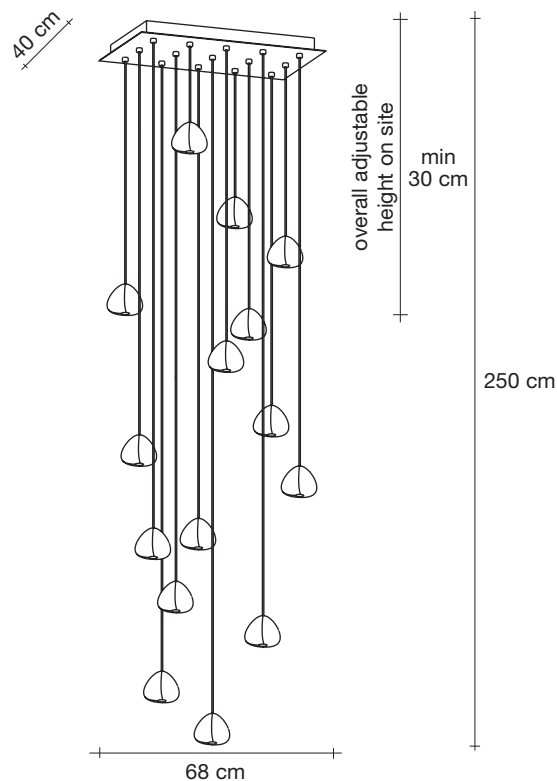

Light source options

230-240V ~ 50/60Hz

 HALOGEN
15 x 10W G4 12V

or

 LED
15 x 2W G4 12V

or

 Built in Replaceable LED Module
15 x 1,5W 2190 lm 3000K
or optional 1935 lm 2700K

dimnable options

 IGBT
0/1-10V
PWM
PUSH
DALI

Canopy | white

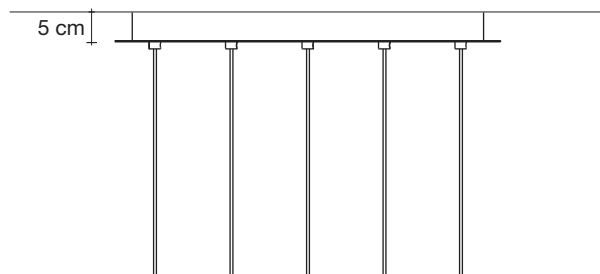
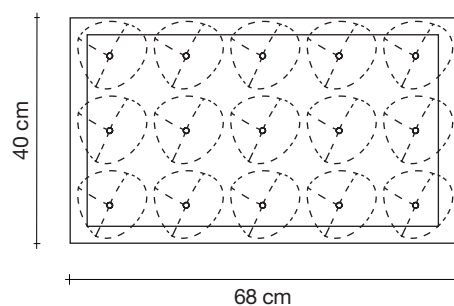

Inspired by the tranquil and mesmerizing light refractions created by water, Mizu is a customizable pendant light from Terzani. Like water droplets, no two Mizu are alike, each crystal shape is unique and made meticulously by hand. Using only the clearest crystal, Mizu perfectly emulates water's refraction of light, casting amazing patterns around the room, reminiscent of flowing water. Available in clear, silver dust, gold, cognac and champagne finish. Design Nicolas Terzani. Made in Italy.

Mizu, flowing *light*.

design Nicolas Terzani
terzani.com







Name
Mizu
15 round multi light pendant

Materials
crystal



Finishes | Code

-  clear
OR15S E8 A9 T
-  champagne
OR15S E8 H1 T
-  cognac
OR15S E8 H4 T
-  silver dust
OR15S E8 F4 T
-  gold
OR15S E8 A4 T

Body

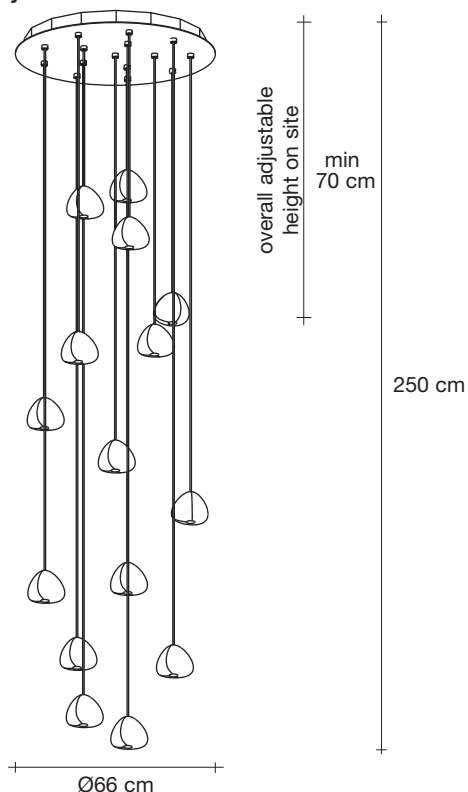

Light source options

230-240V ~ 50/60Hz

 HALOGEN
15 x 10W G4 12V

or

 LED
15 x 2W G4 12V

or

 Built in Replaceable LED Module
15 x 1,5W 2190 lm 3000K
or optional 1935 lm 2700K

dimming options

 IGBT
0/1-10V
PWM
PUSH
DALI

Canopy | white

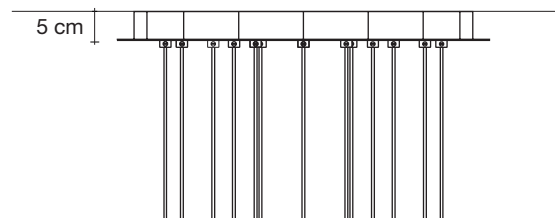
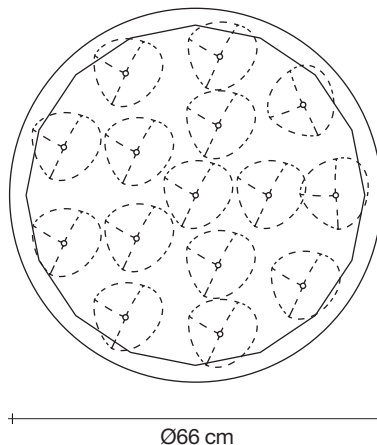

Inspired by the tranquil and mesmerizing light refractions created by water, Mizu is a customizable pendant light from Terzani. Like water droplets, no two Mizu are alike, each crystal shape is unique and made meticulously by hand. Using only the clearest crystal, Mizu perfectly emulates water's refraction of light, casting amazing patterns around the room, reminiscent of flowing water. Available in clear, silver dust, gold, cognac and champagne finish. Design Nicolas Terzani. Made in Italy.

Mizu, flowing *light*.

design Nicolas Terzani
terzani.com

TERZANI
LA LUCE PENSATA







Name
Mizu
26 square multi light pendant

Materials
crystal

CE ENEC CB

Finishes | Code

-  clear
OR26S E8 A9 Q
-  champagne
OR26S E8 H1 Q
-  cognac
OR26S E8 H4 Q
-  silver dust
OR26S E8 F4 Q
-  gold
OR26S E8 A4 Q

Body

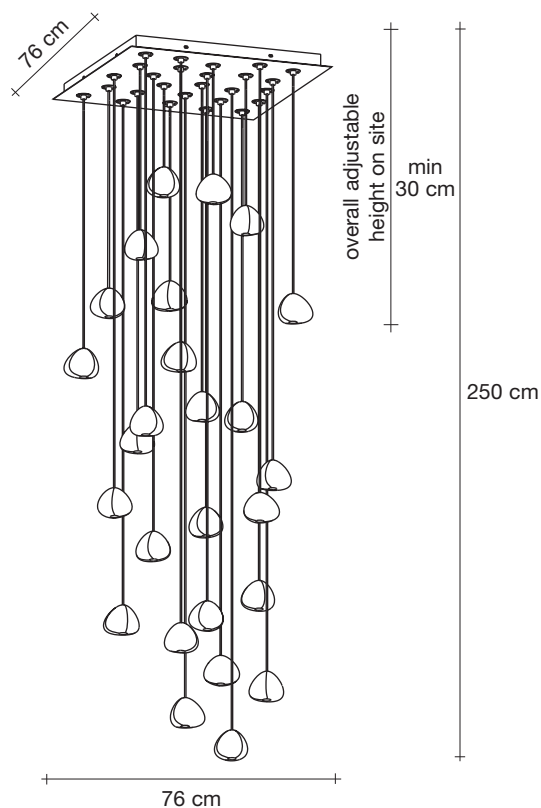

Light source options

230-240V ~ 50/60Hz

 HALOGEN
26 x 10W G4 12V

or

 LED
26 x 2W G4 12V

or

 Built in Replaceable LED Module
26 x 1,5W 3796 lm 3000K
or optional 3354 lm 2700K

dimnable options

 IGBT
0/1-10V
PWM
PUSH
DALI

Canopy | white - quick system

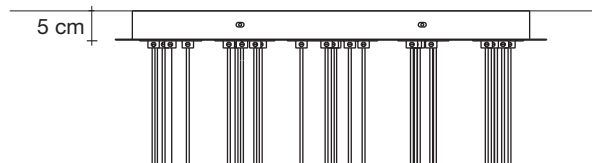
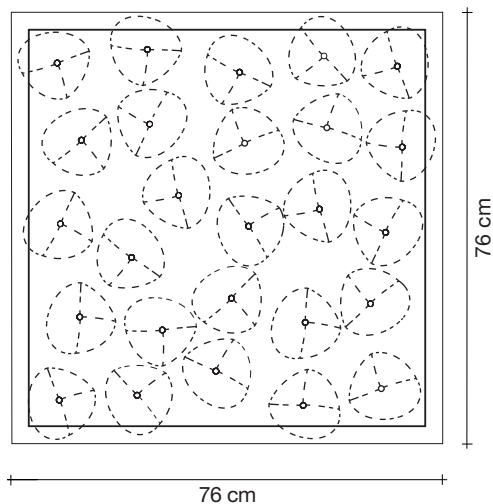

Mizu, flowing *light*.

design Nicolas Terzani
terzani.com







Name
Mizu
26 round multi light pendant

Materials
crystal



Finishes | Code

-  clear
OR26S E8 A9 T
-  champagne
OR26S E8 H1 T
-  cognac
OR26S E8 H4 T
-  silver dust
OR26S E8 F4 T
-  gold
OR26S E8 A4 T

Body

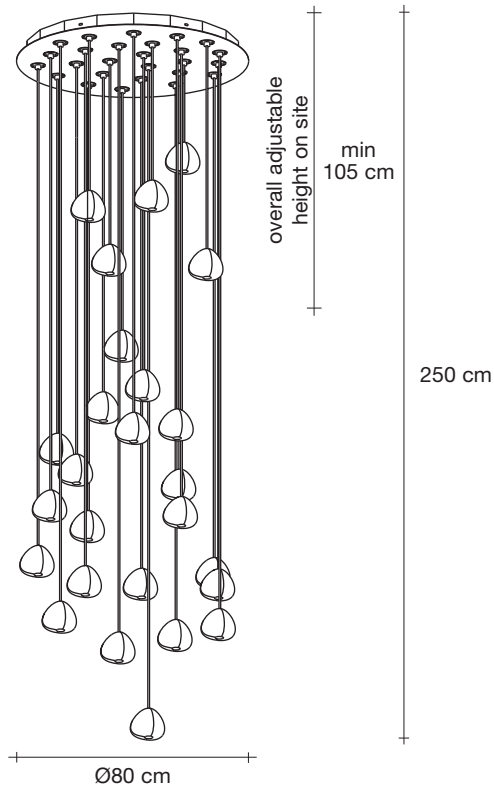

Light source options

230-240V ~ 50/60Hz

 HALOGEN
26 x 10W G4 12V

or

 LED
26 x 2W G4 12V

or

 Built in Replaceable LED Module
26 x 1,5W 3796 lm 3000K
or optional 3354 lm 2700K

dimnable options

 IGBT
0/1-10V
PWM
PUSH
DALI

Canopy | white - quick system

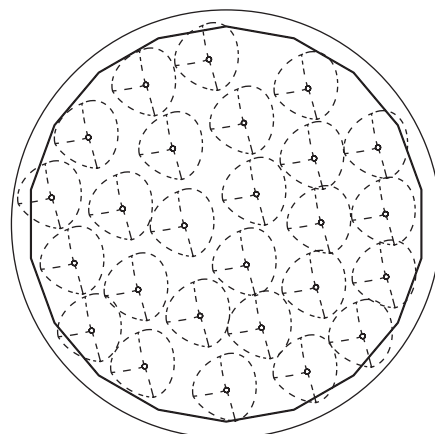

Ø80 cm

