

WHISTLER WALL IP44

FINISH

fritted glass with satin brass details

DIMENSIONS (body of fixture)

140 x 125 x 300 mm (w x d x h)

WEIGHT

3kg (6.6lbs)

ILLUMINATION

220-240v - 1 x GU9 - 25w max halogen (or 2.3 LED 2700k)

110-130v - 1 x GU9 - 25w max halogen (or 2.3 LED 2700k)

our bathroom lights are IP44 rated for 220-240v only
the lights are not damp rated for 110-130v

DIMMING

dimnable bulb required

trailing edge dimmable / phase cut (rotary dimmer) - standard

DALI option available (220-240v only)

WALL MOUNTING PLATE

rectangular wall plate - 120 x 126 mm (w x h)

CERTIFICATION



VIEW ON WEBSITE

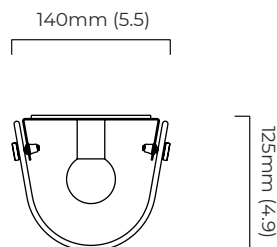
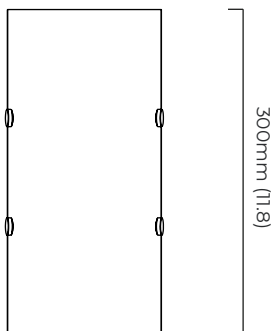

mounting plate dimensions

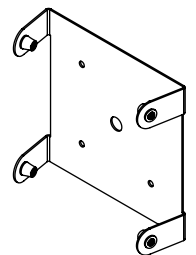
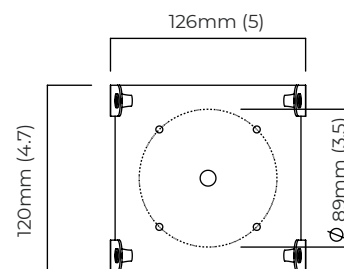

*Diagrams are not to scale.

WHISTLER WALL IP44 - DALI-A

FINISH

fritted glass with satin brass details

DIMENSIONS (body of fixture)

140 x 125 x 300 mm (w x d x h)

WEIGHT

3kg (6.6lbs)

ILLUMINATION

220-240v - 1 x GU9 - 25w max halogen (or 2.3 LED 2700k)
DALI converter to be installed in the cavity

DIMMING

dimnable bulb required
DALI compatible

WALL MOUNTING PLATE

rectangular wall plate - 120 x 126 mm (w x h)

CERTIFICATION



VIEW ON WEBSITE

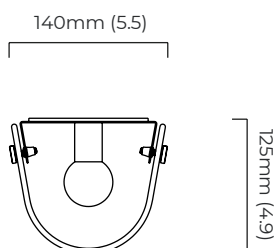
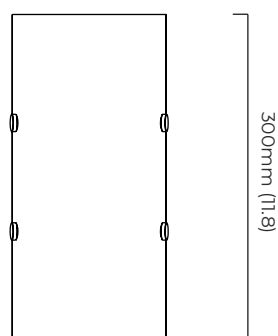

mounting plate dimensions

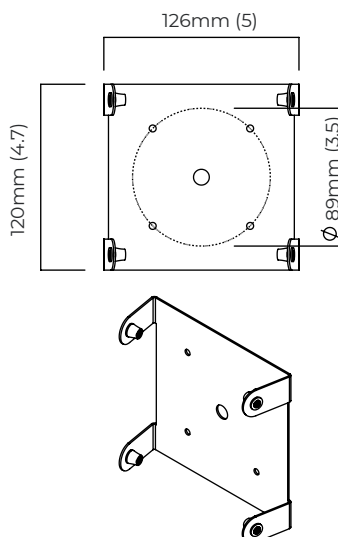

DALI converter dimensions

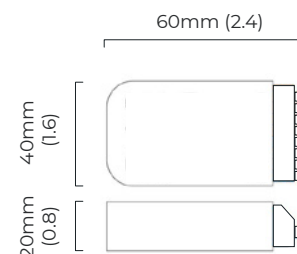

*Diagrams are not to scale.

WHISTLER WALL IP44

WHISTLER WALL IP44

SKU NUMBER	FINISH DESCRIPTION	VOLTAGE
WHIWAOFGSB44-240	fritted glass with satin brass details	220 - 240V
WHIWAOFGSB44-110	fritted glass with satin brass details	110 - 130V

WHISTLER WALL IP44 - DALI-A

SKU NUMBER	FINISH DESCRIPTION	TYPE OF DALI	VOLTAGE
WHIWAOFGSB44-DALIA-240	fritted glass with satin brass details	DALI A included - For lights that do not require aesthetic alterations. Dali can be fitted inside the ceiling/wall cavity	220 - 240V

WHISTLER WALL IP44



The following information is a guide to help you understand what fittings can be placed in a bathroom. This is not an installation guide and reference should be made to the IEE Wiring Regulations (17th Edition) or a qualified electrician.

IP rating stands for “Ingress Protection” and is always followed by two characters. These two numbers refer to the level of protection and it is important that you choose fittings with the correct rating according to where they are to be sited within the bathroom.

When an electrical product is IP44 rated means that it is protected against small objects and water splashing from all directions. In case of lighting fixtures, they are designed for use in bathrooms and other environments where water spray is a risk factor.

The diagram above shows a bathroom split into four clear zones: 0, 1, 2 and 3.

ZONE 0	Is inside the bath or shower area itself. Any fitting used in this zone must be low voltage, (max 12v) and be rated at least IP67 which is total immersion proof.
ZONE 1	Is the area above the bath to a height of 2205 mm from the floor. In this zone a minimum rating of IP44 is required. If the fitting is 240v a 30ma residual current device (RCD) must also be used to protect the circuit in this zone.
ZONE 2	Is an area stretching 600 mm outside the perimeter of the bath and to a height of 3000 mm from the floor. In this zone IP rating of at least IP44 is required. In addition, the area around a wash basin within a 600 mm radius of any tap or water source to be considered as zone 2. In this zone IP rating of at least IP44 is required.
ZONE 3	Is anywhere outside zones 0, 1 and 2 and where no water jet is likely to be used. No IP rating is required. If there is a likelihood of water jets being used for cleaning purpose in zones 1,2 and 3 a fitting rated a minimum of IP65 must be used.

Regarding ceiling lights, when the room's height is less than 3000 mm, then Zone 2 is extended above the surface of the bath or shower base and a minimum of an IP44 light is required.

Full details can be found in the latest copy of the IEE wiring regulations.

IP44 rated wall lights are suitable for use in zones 2 and 3.